

installation



1. The bottom track is the most critical step. Ensure the track is fixed firm and level in both directions. For longer tracks you may require a laser level. Pre-drill the track 100mm from each end and then 500mm apart. The track port is positioned at the stacking side.

2. The first jamb to fix is the one that the door is to stack open against. Ensure the jamb is fixed square on the track and level on both faces. This jamb must be firmly fixed to the wall to carry the weight of the door. Thermalite, breeze block or cavity fixed jamb must be firmly strapped to ensure no side to side or rocking movement.



3. Position the top track on top of the jamb and position, place the other jamb under the top track to hold it in place. If practically possible, do not fix the top track at this stage.

4. Ensure the second jamb is fixed square on the track and level on both faces. This jamb must be firmly fixed to the wall to carry the weight of the door. Thermalite, breeze block or cavity fixed jamb must be firmly strapped to ensure no side to side or rocking movement.



5. Ensure the top track is fixed firm and level in both directions. For longer tracks you may require a laser level. Pre-drill the track 100mm from each end and then 500mm apart. The track port is positioned at the stacking side.

6. Insert all the rollers into the tracks. Ensure the hinge is positioned on the right side.



7. Lift the first panel into position. We recommend that two persons lift the panels. For easy positioning, place timber on the floor so that the top of the timber is 8mm higher than the top of the bottom track. Lift the panel onto the timber. Locate the hinges and fix to the first jamb. Check the panel for parallel positioning and clearance with the tracks.

8. Using the same method as the first panel, fix the second panel. Slide the top and bottom roller onto the panel, position and fix. Check the panel for parallel positioning and clearance with the tracks. Adjustment to the rollers may be required at this stage.



9. Attach the swing panel and check that the door closes correctly. If it is too tight or if there is a gap, pack the back of the jambs accordingly.

Note: For 4,5 and 6 panel door sets, repeat steps 7 and 8. For 2, 4, or 6 panels folding in one direction, a solid hinge is attached to the top and bottom roller of the last panel.

10. Insert fixing covers into the jambs and seal the perimeter of the door frame.



See toe and heel & roller adjustment

Recommended Top Track Fixing Details

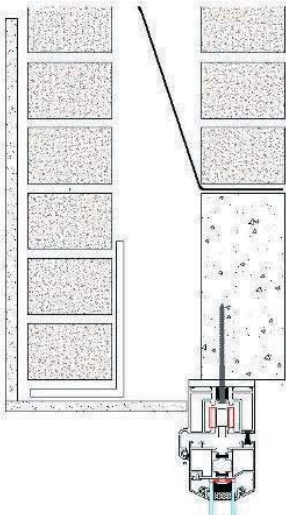

Concrete or
Timber Lintel

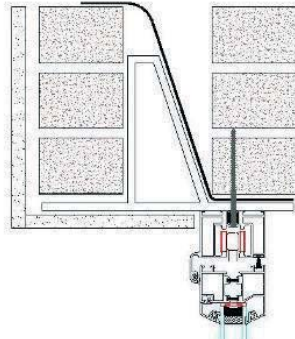

Catnic (with fixing screw
fixed into the brick)

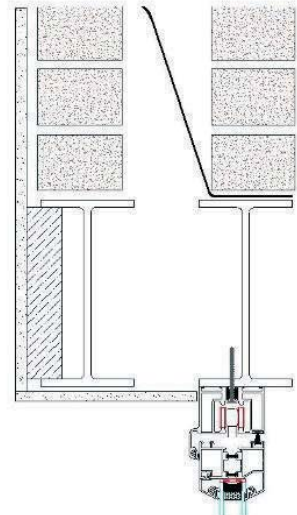

Re-enforced
Steel Joist

FOLDING SLIDING DOOR & FIXED FRAME CILL OPTIONS

These cill options are example details and apply to all systems—Our timber system has been used for the purpose of illustration.

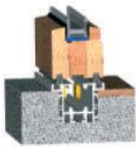

OPTION 1



OPTION 2



OPTION 3

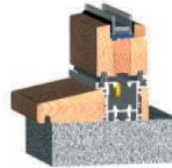

OPTION 4

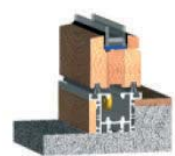

OPTION 5



OPTION 6

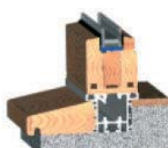

OPTION 7



OPTION 8

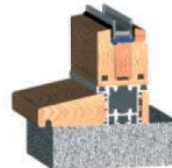

OPTION 9



OPTION 10



OPTION 11



OPTION 12



OPTION 13



OPTION 14



OPTION 15

toe & heeling glass

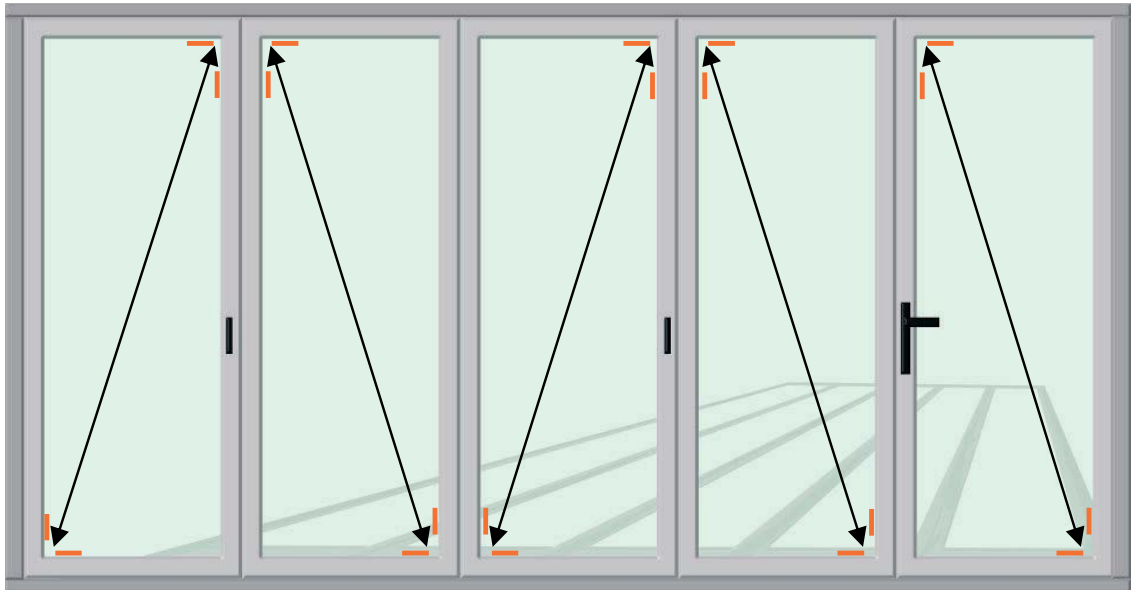

The — indicates where the toe and heel packers are placed to allow the glass to lift the panels. The arrows indicate the brace direction. It is essential that the door glass is correctly toe and heeled as shown to ensure smooth operation of the doors when opening them.

adjustable toe and heel device



1. The locking panels on your Folding Sliding Doors are Pre-factory glazed & fitted with an adjustable toe and heel device.
2. In the top of each locking panel you will find a Pozi-Head screw bolt.
3. The doors panels will already be at their lowest point.
4. With the doors in the closed position, identify any panels that require lifting.
5. Open the doors so that you can get access to the adjustable toe and heel device at the top of the door panel
6. Pack the doors underneath the door (between the floor and door panel).
7. Wind the screw head clockwise, this will cause the corner of the door to rise.
8. Re-close the doors and check that they run parallel and evenly to the top and bottom tracks.
9. If they do not, then repeat as necessary.



These examples will help to determine where all parts are fitted to other configurations



adjusting a roller

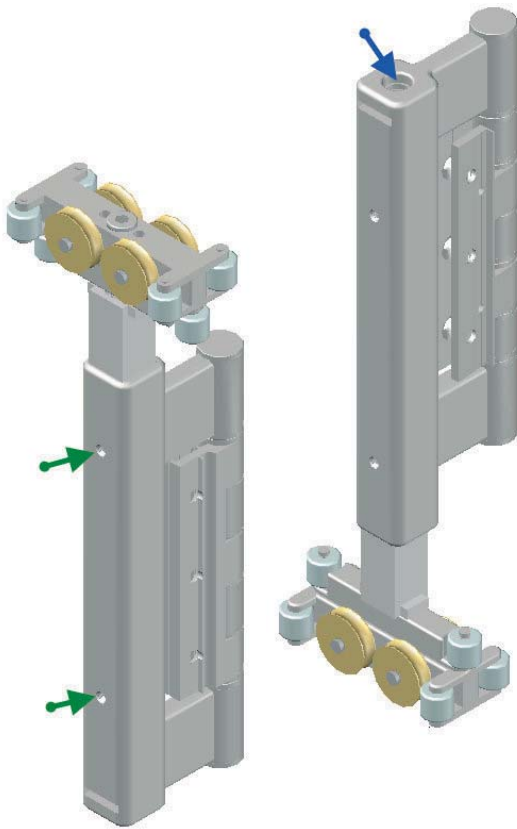

This roller assembly has three grub screws.

The grub screw on the hinge is to lock the hinge in position and maintains high security, without it, the hinge is vulnerable to crime.

The grub screws on the roller carrier (green arrows) are to lock the roller into position after adjustment.

Adjust the roller by unlocking the grub screws (green arrows) and turn the allen bolt (blue arrow).

This moves the roller up and down.

Tighten the grub screws to secure the adjustment. (green arrows)

installing a pull handle

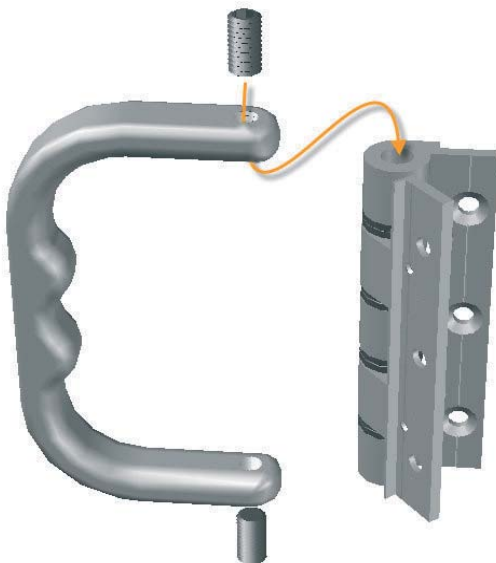

To install a pull handle.

Remove the top and bottom cover caps from the middle hinge near the flat handle.

Place the pull handle over the hinge.

Tighten the grub bolts.

resetting a disengaged shoot bolt

On vary rare occasions the locking mechanism has become disengaged from the shoot bolt. This is usually caused by trying to force the lock when the door is not closed in line with the tracks.



1. Unscrew the screws on the shoot bolt and the first couple of screws on the lock. Then slide the cover plate up.



2. Underneath you will see the 'teeth' on the main part of the locking system; this should have a slight bend on it (if not, this can be bent slightly).



3. Replace the top screw on the shoot bolt.



4. Ensure the shoot bolt is fully retracted and the lock is in the unlocked position before re-engaging the lock teeth into the shoot bolt.



5. Replace all screws in the lock

cleaning

glass

External grime should be removed with a solution of soap and water
Any cleaner used should not be allowed to run down on any other surface.
Any household glass cleaner may be used with a soft cloth

NOTE: The glass used in most double glazed units, is easily scratched and it is therefore recommended that hand jewellery is removed prior to cleaning.

panels & door frame

Wash frames and panels with soap and water solution at least :-

Every three months in areas of heavy traffic, industry or located near the sea
Every six months in rural areas

If required clean with a non-abrasive proprietary cleaner, suitable for either plastics, aluminium or timber, using a soft cloth. In the event of unusually heavy staining, advice should be sought from The Folding Sliding Door Company.

Any damage to the paint coating, such as scratches, chips or areas of abrasion, must be repaired immediately.

NOTE: Avoid all solvent based or abrasive cleaners. Take care not to disturb silicone pointing sealants.

tracks

Tracks must remain clean and clear at all times. Dust and dirt can build up on the roller mechanism and foul the smooth running of the door.

The tracks can be cleaned using a long bristle paint brush and vacuumed with a thin nozzle attachment.

rollers

Every 3 to 6 months, thoroughly clean and dry all upper and lower rollers and all hinges. Liberally apply lubricant such as Teflon spray (no grease) on the wheels and bearings of the rollers.

Oil all hinges including the hinge pin with light weight lubricating oil or Teflon spray.



maintenance

glass scratches

If scratches occur, most can be removed with jewellers rouge available from your local glass supplier, or an equivalent rubbing compound. Alternatively, seek professional advice.

Replacement of sealed units should be carried out by professionals in accordance with BS6262, the units complying with BS EN 1279.

PVC-u profiles

PVC-u requires no maintenance other than cleaning. In the event of damage, seek advice from The Folding Sliding Door Company. Periodically and where accessible, clear drainage holes which can be seen when you open the door.

gaskets

If the gaskets are broken or damaged and draughts are felt around the unit, ensure prompt replacement by The Folding Sliding Door Company.

Use a light soapy solution and a non-abrasive cloth. **DO NOT USE** solvent based cleaning products on the gaskets. It is recommended that silicon spray is applied to the gaskets annually.

hardware fittings

Every 3 to 6 months, thoroughly clean and dry all upper and lower rollers and all hinges. Liberally apply lubricant such as Teflon spray (no grease) on the wheels and bearings of the rollers.

Oil all hinges including the hinge pin with light weight lubricating oil or Teflon spray, wipe away any excess with a non-abrasive cloth once you have finished.

handles

There is no maintenance required for the door handles.

silicone seals

NOTE: Some discolouration of the silicone pointing sealant is natural occurrence and cannot be avoided.

HOW TO OPERATE (RIGHT HAND STACKING **OUTWARD OPENING**)

****IMPORTANT: REMOVE KEYS PRIOR TO FOLDING OPEN****

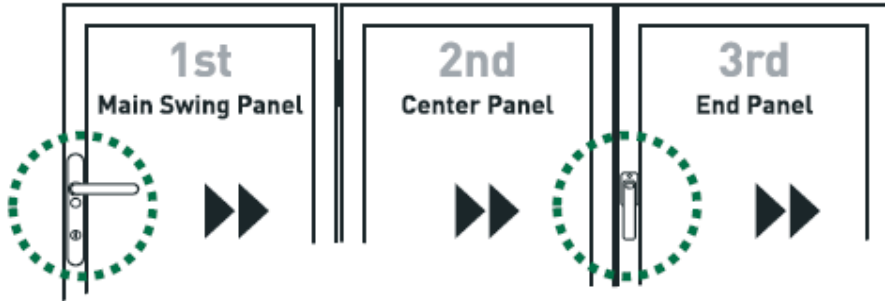

- 1** Starting from main swing panel, OPERATE lever handle then outward open MAIN SWING PANEL inline with adjacent centre panel.
- 2** Release Bi-Fold handle(s) then PUSH centre panel adjacent to end panel.
- 3** Fold all panels back against the wall for maximum opening.

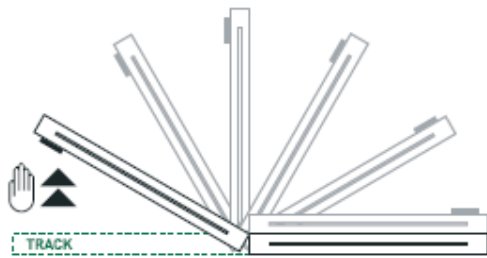

STAGE 1 (INSIDE VIEW)
Swing door opens first
Fold fully back in-line

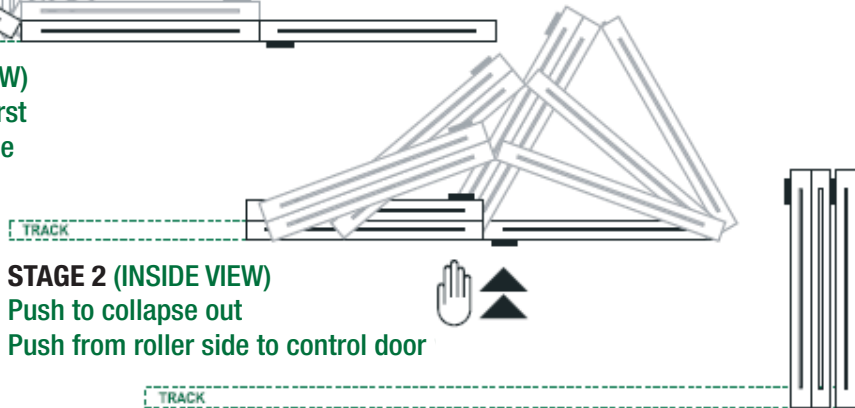

STAGE 2 (INSIDE VIEW)
Push to collapse out
Push from roller side to control door

STAGE 3 (INSIDE VIEW) Fully open position

HOW TO CLOSE

- 1** Hold panels 2 & 3 and walk in the direction of the track.
- 2** The rollers are utilised giving a smooth closure to the bi-fold door.
- 3** Close and secure the end swing panel.
LOCK BOTH LEVER HANDLE AND FLAT HANDLE

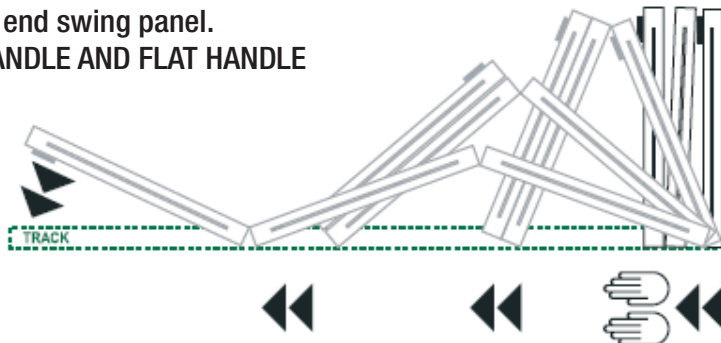

HOW TO OPERATE (LEFT HAND STACKING **OUTWARD OPENING**)

****IMPORTANT: REMOVE KEYS PRIOR TO FOLDING OPEN****

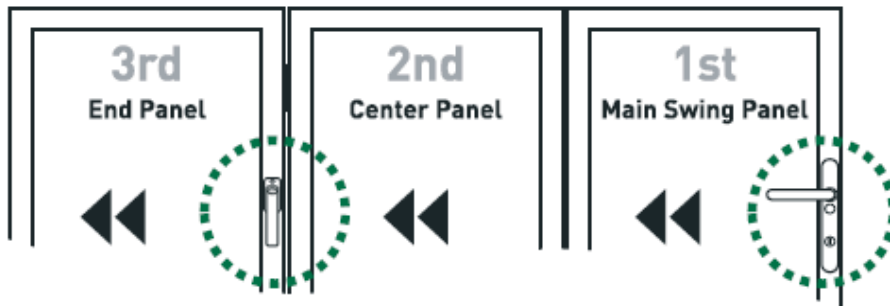

- 1** Starting from main swing panel, OPERATE lever handle then outward open MAIN SWING PANEL inline with adjacent centre panel.
- 2** Release Bi-Fold handle(s) then PUSH centre panel adjacent to end panel.
- 3** Fold all panels back against the wall for maximum opening.

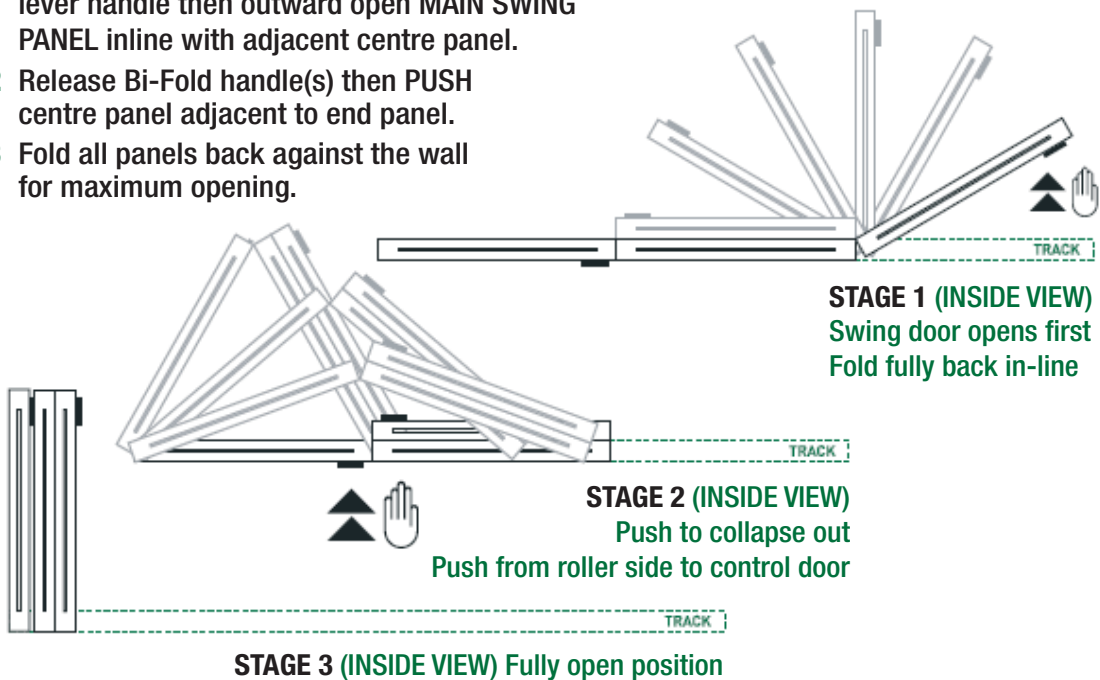

HOW TO CLOSE

- 1** Hold panels 2 & 3 and walk in the direction of the track.
- 2** The rollers are utilised giving a smooth closure to the bi-fold door.
- 3** Close and secure the end swing panel.
LOCK BOTH LEVER HANDLE AND FLAT HANDLE

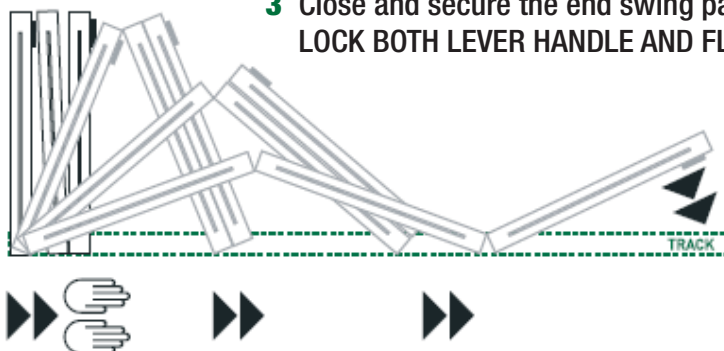

HOW TO OPERATE (RIGHT HAND STACKING **OUTWARD OPENING**)

****IMPORTANT: REMOVE KEYS PRIOR TO FOLDING OPEN****

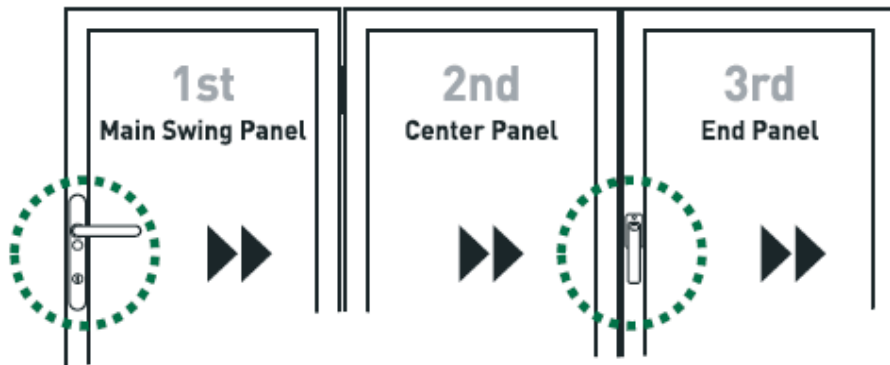

HOW TO OPERATE YOUR **LEVER HANDLE**

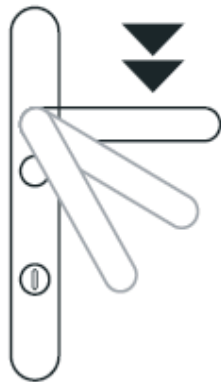

1. To Open
Use key, depress handle
to dis-engage locks



2. To Open
Keep handle depressed
Push to outward open

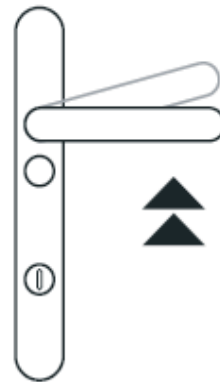

3. Lock(ing) position
Lift handle slightly to
engage locks, use key

HOW TO OPERATE YOUR **BI-FOLD HANDLE**



Locked position
180 Degrees Flat



To Open
Lift handle up

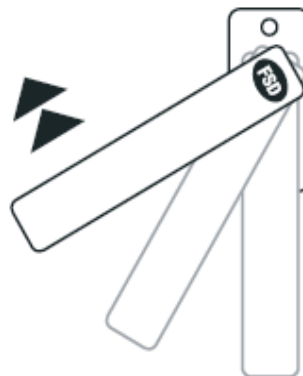

Turn handle clockwise to disengage
locks (45 Degrees) and pull to open

HOW TO OPERATE (LEFT HAND STACKING **OUTWARD OPENING**)

****IMPORTANT: REMOVE KEYS PRIOR TO FOLDING OPEN****

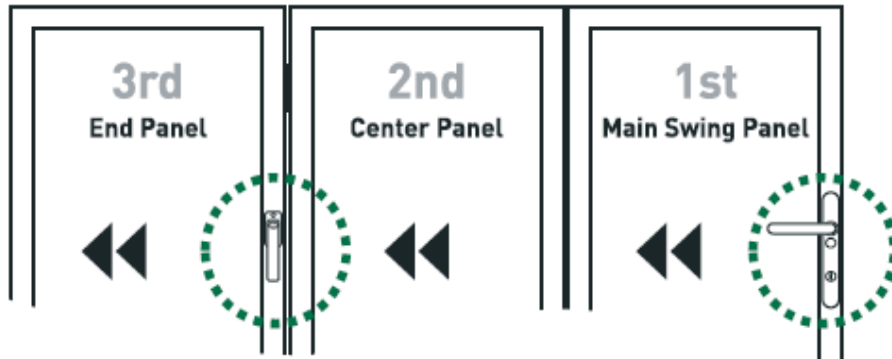

HOW TO OPERATE YOUR **LEVER HANDLE**

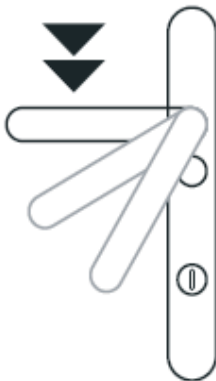

1. To Open
Use key, depress handle
to dis-engage locks



2. To Open
Keep handle depressed
Push to outward open

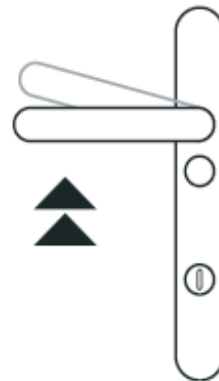

3. Lock(ing) position
Lift handle slightly to
engage locks, use key

HOW TO OPERATE YOUR **BI-FOLD HANDLE**



Locked position
180 Degrees Flat

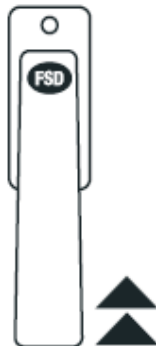

To Open
Lift handle up

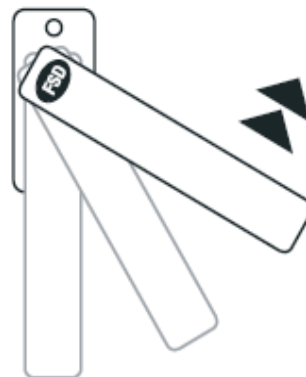

Turn handle clockwise to disengage
locks (45 Degrees) and pull to open

condensation



Condensation is moisture-laden air converted into water. The atmosphere in which we live is generally invisible. The warmer the air is the more moisture it can hold, when its limit is reached and the warm air makes contact with a cold non absorbent surface, it becomes chilled and sheds the surplus moisture in the form of water droplets, usually on glass surface.

causes & cures

living Room

- Allow the room's warmth to reach windows by positioning the curtains approximately 150mm from the glass.
- Where possible, avoid glazed or non-absorbent wall coating.
- Where flues have been blocked off, wall vents are most helpful.
- Vent holes below gas fires help to facilitate ventilation.
- Open windows for short periods each day to allow air change.

bedroom

- The prime cause for condensation in the bedroom is not allowing for the night-time drop in outside temperature.
- Extend the central heating programme or other heating system according.
- Ventilate by opening the windows at least once a day to allow air change.

kitchen

- Close door ways into the remainder of the house and keep a window open.
- Extractor fans etc, can help.



ggf guide: viewing glass



Double glazing provides a high standard of vision. The following is a guide to the quality that can be expected.

Transparent glass used in the manufacture of insulating glass is identical to that used traditionally for single glass and will, therefore, have a similar level of quality.

how to do a professional check

Stand in the room no less than 2 metres away from the panes and look directly through them. For toughened, laminated or coated glasses, stand no less than 3 metres away. Do so in natural daylight, but not looking directly towards the sun and with no visible moisture on the surface of the glass. Where it is not possible to stand at the required distance, then stand as far away as you can from the panes.

Exclude from the check the 50mm wide band around the edge of the glass.

what to expect

Flat transparent glass, including laminated or toughened (tempered) or coated glass is acceptable if the following are neither obtrusive nor bunched:

- bubbles or blisters
- hairlines or blobs
- fine scratches under 25mm long
- minute particles

The obtrusiveness of blemishes is judged by looking through the glass, not at it, under natural light. It must be understood that the glass used in double glazing is not ground optically flat, and so as a consequence, blemishes are a possibility.

special glasses

Toughened glass may show visual distortions which are accentuated by reflections in double glazing. Such surface colourations and patterns do not indicate a change in physical performance.

Laminated glass may have a few more blemishes due to it being made of several layers.

As a legal requirement, glass intended for use as a safety glass must display a permanent safety mark which is applied before installation, but remains visible after installation. The mark must comply with the requirements of the British Standard BS6206 Specification for Impact Performance Requirements for Flat Safety Glass and Safety Plastics for Use in Buildings, or its successor.

As a legal requirement, glass intended for use as a safety glass must display a permanent safety mark which is applied before installation, but remains visible after installation. The mark must comply with the requirements of the British Standard BS6206 Specification for Impact Performance Requirements for Flat Safety Glass and Safety Plastics for Use in Buildings, or its successor.

double reflection

This occurs in certain light conditions. It is caused by multiple surface reflections in double glazing which may vary from pane to pane.

Brewster's Fringes - the rainbow effect
Small transitory rainbow effects are sometimes produced by the glass deflecting light. Their appearance is due to high quality flat glass sheets being placed parallel to each other.

patterned glass

The above does not apply to patterned glass as its manufacturing process is different.